



VEX-X5101TR-B1C

UHD⁺ 2x1 HDMI/DP to HDMI Bi-directional
AV over IP Transceiver



Operation Manual



HDMI[®]
HIGH-DEFINITION MULTIMEDIA INTERFACE

The terms HDMI, HDMI High-Definition Multimedia Interface, and the HDMI Logo are trademarks or registered trademarks of HDMI Licensing Administrator, Inc.

DISCLAIMERS

The information in this manual has been carefully checked and is believed to be accurate. Cypress Technology assumes no responsibility for any infringements of patents or other rights of third parties which may result from its use.

Cypress Technology assumes no responsibility for any inaccuracies that may be contained in this document. Cypress also makes no commitment to update or to keep current the information contained in this document.

Cypress Technology reserves the right to make improvements to this document and/or product at any time and without notice.

COPYRIGHT NOTICE

No part of this document may be reproduced, transmitted, transcribed, stored in a retrieval system, or any of its part translated into any language or computer file, in any form or by any means—electronic, mechanical, magnetic, optical, chemical, manual, or otherwise—without express written permission and consent from Cypress Technology.

© Copyright 2018 by Cypress Technology.

All Rights Reserved.

TRADEMARK ACKNOWLEDGMENTS

All products or service names mentioned in this document are trademarks of the companies with which they are associated.



SAFETY PRECAUTIONS

Please read all instructions before attempting to unpack, install or operate this equipment and before connecting the power supply. Please keep the following in mind as you unpack and install this equipment:

- Always follow basic safety precautions to reduce the risk of fire, electrical shock and injury to persons.
- To prevent fire or shock hazard, do not expose the unit to rain, moisture or install this product near water.
- Never spill liquid of any kind on or into this product.
- Never push an object of any kind into this product through any openings or empty slots in the unit, as you may damage parts inside the unit.
- Do not attach the power supply cabling to building surfaces.
- Use only the supplied power supply unit (PSU). Do not use the PSU if it is damaged.
- Do not allow anything to rest on the power cabling or allow any weight to be placed upon it or any person walk on it.
- To protect the unit from overheating, do not block any vents or openings in the unit housing that provide ventilation and allow for sufficient space for air to circulate around the unit.
- Please completely disconnect the power when the unit is not in use to avoid wasting electricity.

VERSION HISTORY

REV.	DATE	SUMMARY OF CHANGE
RDV1	2021/10/14	Preliminary release

CONTENTS

1. Introduction	1
2. Applications	1
3. Package Contents	1
4. System Requirements	2
5. Features	2
6. Operation Controls and Functions	3
6.1 Front Panel.....	3
6.2 Rear Panel.....	4
6.3 IR Cable Pinouts.....	6
6.4 RS-232 Pinout and Defaults	6
6.5 OSD Menu.....	7
6.6 Basic AV Extension.....	14
6.6.1 Point-to-Point (One Way)	14
6.6.2 Point-to-Point (Bi-directional)	14
7. Connection Diagram	15
8. Specifications	16
8.1 Technical Specifications	16
8.2 Video Specifications	17
8.3 Audio Specifications	19
8.3.1 Digital Audio	19
8.3.2 Analog Audio	20
8.4 Cable Specifications	21
9. Acronyms	22





1. INTRODUCTION

This Transceiver is designed for high-quality, IP routable, AV extension with minimum latency. Every Transceiver is capable of simultaneous bi-directional AV extension, enhancing the flexibility of any installation. By using a sophisticated ultra-light compression scheme (lossless for most content) it's a great solution for extending 4K audio/video streams (HDMI or DisplayPort) and data. Advanced HDMI content such as HDR (High Dynamic Range), 10-bit color and multi-channel HD Bitstream audio can be transmitted in pass-through mode. The use of high quality 10 Gigabit Ethernet ports and Cat.6A or better cable allows for point-to-point transmission distances up to 100m. Multiple control and data signals may also be transmitted along with the audio and video, including IR, RS-232, USB (HID only), and Ethernet.

The built-in EDID and HDCP management functionality enables the unit to fit into every situation. Basic configuration of the unit can be achieved via front panel buttons with an OSD (On-Screen Display).

2. APPLICATIONS

- Video, Audio, LAN, IR, and USB (HID only) over 10GbE extension
- Point-to-Point Secure Video Conferencing
- Hotel or convention center display
- Remote KVM system control

3. PACKAGE CONTENTS

- 1× UHD⁺ 2×1 HDMI/DP to HDMI Bi-directional AV over IP Transceiver
- 1× 12V/3A DC Power Adapter
- 1× Power Cord
- 1× Operation Manual

4. SYSTEM REQUIREMENTS

- HDMI or DisplayPort source equipment such as a media player, video game console, PC, or set-top box
- HDMI receiving equipment such as an HDTV, monitor, or audio amplifier
- Analog audio receiving equipment such as headphones, an audio amplifier, or powered speakers
- The use of Premium High Speed HDMI cables, and industry standard Cat.6A, or Cat.7 Ethernet cable is required.

5. FEATURES

- HDMI 2.0 and DVI 1.0 compatible
- HDCP 2.2 and HDCP 1.x compliant
- Transceiver with support for simultaneous bi-directional AV signal extension
- 1 HDMI and 1 DisplayPort input
- 1 HDMI output
- 1 analog stereo input & 1 analog stereo output
- 2 USB (Type-A) ports (HID support only) and 1 USB 2.0 (Mini-B) port
- Ultra-light compression, lossless for most content
- Extension up to 100m in Point-to-Point mode (with Cat.6A cable)
- Supports pass-through of 10/12-bit HDR sources
- Supports pass-through of audio formats including LPCM (up to 8 channels), Bitstream and HD Bitstream from HDMI or DP sources
- Bi-directional AV, IR, RS-232, USB (HID only), and Ethernet extension
- Basic configuration via front panel buttons with an OSD
- Supports the use of an external control center (IP Master Controller) or control software to make adjustments to some functionality (Contact your authorized dealer for more information)

6. OPERATION CONTROLS AND FUNCTIONS

6.1 Front Panel

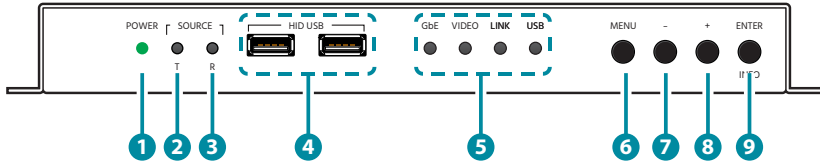

- 1 POWER LED:** This LED will illuminate to indicate the unit is on and receiving power.
- 2 SOURCE T LED:** The illumination of this LED indicates which AV input is currently selected to be the source transmitted as an AV over IP stream. Green indicates the local HDMI input, amber indicates the local DisplayPort input, off indicates the incoming AVoIP stream.
- 3 SOURCE R LED:** The illumination of this LED indicates which AV input is currently selected as the source to be output over the local HDMI output. Green indicates the local HDMI input, amber indicates the local DisplayPort input, off indicates the incoming AVoIP stream.
- 4 HID USB (Type-A) Ports:** Connect directly to standard USB human interface devices such as a mouse or keyboard to extend their USB functionality to the currently active/routed transceiver with an active host port.
- 5 STATUS LED BLOCK:**
 - **GbE LED:** This LED will illuminate and blink to indicate a live and active connection on the local gigabit Ethernet port.
 - **VIDEO LED:** This LED indicates video streaming activity over the CAT6A/7 port. It will illuminate green when a video signal is being transmitted and amber when a video signal is being received. When bi-directional video streaming is active, both colors will illuminate. When no video is active the LED will remain off, even if the streaming connection is valid.
 - **LINK LED:** These LEDs will illuminate and blink to indicate data transmission and reception activity across the CAT6A/7 streaming connection.
 - **USB LED:** This LED will illuminate when the unit's USB ports have successfully paired with the USB ports on another unit. This LED will blink if the unit's USB ports are not currently paired and in stand-by mode.

- 6 MENU Button:** Press to enter the OSD menu, or to back out from menu items.

Note: The OSD menu will be visible on the HDMI output of both connected transceivers so it is recommended to adjust the OSD position on one unit to avoid the menus overlapping.

- 7 – (MINUS) Button:** Press to move up or adjust selections within OSD menus. When not in a menu, press to manually switch between “T” source inputs.

- 8 + (PLUS) Button:** Press to move up or adjust selections within OSD menus. When not in a menu, press to manually switch between “R” source inputs.

- 9 ENTER/INFO Button:** When inside an OSD menu, press to confirm a selection or to go deeper into a menu item. When not in a menu, press to activate the Information OSD.

6.2 Rear Panel

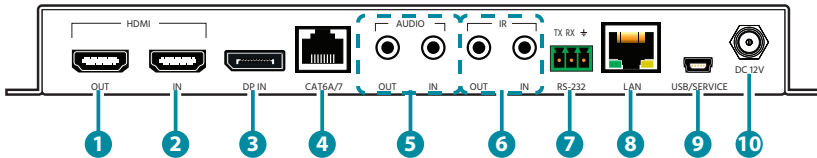

- 1 HDMI OUT Port:** Connect to an HDMI TV, monitor, or amplifier for digital video and audio output.
- 2 HDMI IN Port:** Connect to HDMI source equipment such as a media player, game console, or set-top box.
- 3 DP IN Port:** Connect to DisplayPort source equipment such as a PC or laptop.
- 4 CAT6A/7 Port:** Connect directly to a compatible transceiver for bi-directional Point-to-Point extension.

5 AUDIO PORTS:

- **OUT Port:** Connect to powered speakers or an amplifier for stereo analog audio output.
- **IN Port:** Connect to the stereo analog output of a device such as a CD player or PC.

Note: Audio is routed directly from the IN Port to the opposite transceiver's OUT Port.

6 IR PORTS:

- **OUT Port:** Connect to an IR Blaster to broadcast IR signals from a connected transceiver to devices within direct line-of sight of the IR Blaster.
- **IN Port:** Connect to an IR Extender to receive IR control signals and extend them to devices connected to a connected transceiver. Ensure that the remote being used is within direct line-of-sight of the IR Extender.

Note: Currently, only 38KHz IR signal extension is supported.

- 7 **RS-232 3-pin Terminal Block:** Connect directly to a PC, laptop or serial controllable device with a 3-pin adapter cable to extend the RS-232 signal between transceivers.

- 8 **LAN Port:** Connect to an Ethernet supporting device or to your local network as appropriate to extend the network between transceivers.

- 9 **USB/SERVICE (Mini-B) Port:** Connect directly to a standard USB host such as a PC or laptop to extend their USB functionality to all currently connected/routed USB devices.

Note: This port is only active when "USB Control Mode" is set to "Device". Only one of the two connected transceivers should be set as a USB Device to avoid conflicts.

- 10 **DC 12V Port:** Plug the 12V DC power adapter into this port and connect it to an AC wall outlet for power.

6.3 IR Cable Pinouts

IR Blaster Cable

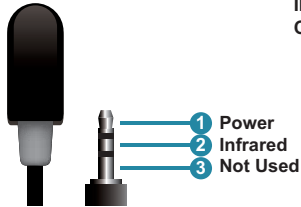

IR Extender Cable

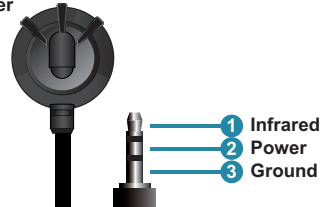

6.4 RS-232 Pinout and Defaults

Serial Port Default Settings	
Baud Rate	57600
Data Bits	8
Parity Bits	None
Stop Bits	1
Flow Control	None

3-pin Terminal Block

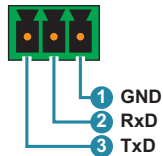

Note: The default Serial Port baud rate can only be changed by use of the optional IP Master Controller or control software.

6.5 OSD Menu

All functions of this unit can be controlled by using the OSD (On Screen Display) which is activated by pressing the MENU button on the front of the unit. Use the + (PLUS), - (MINUS), and ENTER buttons to navigate the OSD menu. Press the MENU button to back out from any menu item and then press it again to close the menu.

MAIN MENU
OSD
EDID
HDCP
Device Setting
Information
Factory Setting

The individual functions of the OSD will be introduced in the following section. Items marked in **BOLD** are the factory default settings.

OSD	
2ND LEVEL	3RD LEVEL
Display Information	ON
	Off
Information Timeout	Off
	10~40 Sec (10 Sec)
Menu Timeout	Off
	10~40 Sec (10 Sec)
Menu H Position	0~100 (10)
Menu V Position	0~100 (10)

- 1) **Display Information:** Enable or disable the Information OSD.
- 2) **Information Timeout:** Set the display timeout for the Information OSD.
- 3) **Menu Timeout:** Set the display timeout for the OSD Menu.
- 4) **Menu H Position:** Set the horizontal position of the OSD Menu.
- 5) **Menu V Position:** Set the horizontal position of the OSD Menu.

EDID	
2ND LEVEL	3RD LEVEL
HDMI EDID	INTERNAL 1 (FHD 2CH)
	Internal 2 (FHD MCh)
	Internal 3 (UHD 2Ch)
	Internal 4 (UHD MCh)
	Internal 5 (UHD+ 2Ch)
	Internal 6 (UHD+ MCh)
	External A [HDMI Output]
	External B [VoIP Output]
	User 1
	User 2
DP EDID	INTERNAL 1 (FHD 2CH)
	Internal 2 (FHD MCh)
	Internal 3 (UHD 2Ch)
	Internal 4 (UHD MCh)
	Internal 5 (UHD+ 2Ch)
	Internal 6 (UHD+ MCh)
	External A [HDMI Out]
	External B [VoIP Out]
	User 1
	User 2
VOIP EDID	EXTERNAL A

- 1) **HDMI EDID:** Select the EDID to send to the unit's HDMI input.
- 2) **DP EDID:** Select the EDID to send to the unit's DisplayPort input.
- 3) **VOIP EDID:** The EDID provided to Video over IP connections is always set to use the EDID from the unit's local HDMI output.

This unit provides the following 6 default EDIDs:

Unit's default EDIDs	
FHD 2CH	1920×1080p@60Hz (4.95Gbps), 8-bit color, LPCM 2.0
FHD MCH	1920×1080p@60Hz (4.95Gbps), 8-bit color, LPCM 7.1 & Bitstream
UHD 2CH	3840×2160p@30Hz (10.2Gbps), 12-bit Deep Color, LPCM 2.0
UHD MCH	3840×2160p@30Hz (10.2Gbps), 12-bit Deep Color, LPCM 7.1 & Bitstream
UHD+ 2CH	3840×2160p@60Hz (18Gbps), 12-bit Deep Color, LPCM 2.0
UHD+ MCH	3840×2160p@60Hz (18Gbps), 12-bit Deep Color, LPCM 7.1 & Bitstream

Note: In some rare cases it is possible for custom or external EDIDs to cause compatibility issues with certain sources. If this happens, it is recommended to switch to one of the 6 default EDIDs for maximum compatibility.

HDCP	
2ND LEVEL	3RD LEVEL
HDMI HDCP	Disable
	Follow out
	Follow in
	FOLLOW API
DP HDCP	Disable
	Follow out
	Follow in
	FOLLOW API
VOIP HDCP	FOLLOW IN

- 1) **HDMI HDCP:** Selects the HDCP logic to use with the HDMI input.
 - **Follow In:** The input supports up to the HDCP version required by the connected source.
 - **Follow Out:** The input supports up to the HDCP version supported by the connected display.
 - **Disable:** HDCP support is completely disabled.
 - **Follow API:** Uses the HDCP setting defined by the IP Master Controller or control software.

Note: In a Point-to-Point configuration, “Follow API” will behave the same as “Follow Out”, if the API hasn’t been manually redefined.
- 2) **DP EDID:** Selects the HDCP logic to use with the DisplayPort input.
 - **Follow In:** The input supports up to the HDCP version required by the connected source.
 - **Follow Out:** The input supports up to the HDCP version supported by the connected display.
 - **Disable:** HDCP support is completely disabled.
 - **Follow API:** Uses the HDCP setting defined by the IP Master Controller or control software.

Note: In a Point-to-Point configuration, “Follow API” will behave the same as “Follow Out”, if the API hasn’t been manually redefined.
- 3) **VOIP EDID:** The Video over IP HDCP behavior is always “Follow In”.

DEVICE SETTING	
2ND LEVEL	3RD LEVEL
Status	TRANSCEIVER
USB Control Mode	HOST
	Device
HDMI Out Source	INPUT 1 (HDMI)
	Input 2 (DP)
	Input 3 (VOIP)
VOIP Out Source	INPUT 1 (HDMI)
	Input 2 (DP)
	Input 3 (VOIP)
HDMI Out Auto Mode	Off
	AUTO SWITCH
VOIP Out Auto Mode	Off
	AUTO SWITCH

- 1) **Status:** Displays the unit's current operational mode.
Note: Due to this unit's support of bi-directional transmission, the status will always be set to "Transceiver".
- 2) **USB Control Mode:** Enable or disable the USB 2.0 (Mini-B) port for connection to USB host devices such as a PC or laptop. Selecting "Device" enables the USB 2.0 (Mini-B) port. Selecting "Host" disables the USB 2.0 (Mini-B) port.
Note: Only one of the two transceivers should be set to "Device" to avoid conflicts.
- 3) **HDMI Out Source:** Select the input source to display on the HDMI output.
- 4) **VOIP Out Source:** Select the input source to transmit as an AV over IP stream.
- 5) **HDMI Out Auto Mode:** Enable or disable the HDMI output's automatic source selection mode. When enabled, the unit will automatically switch the input routed to the local HDMI output whenever a new source is detected or if the current source is lost.

- 6) **VOIP Out Auto Mode:** Enable or disable the AVoIP streaming output's automatic source selection mode. When enabled, the unit will automatically switch the input routed to the AVoIP output whenever a new source is detected or if the current source is lost.

INFORMATION	
2ND LEVEL	3RD LEVEL
Resolution	[Current Source Resolution]
Status	[Current Transceiver Mode]
FW Version	[Current Firmware Version]
IP	[Current IP Address]
MAC	[Unit's MAC Address]
SN	[Unit's Serial Number]

- 1) **Information:** Shows details of the unit's current status including detected source resolution, transceiver mode, firmware version, IP address, MAC address, and serial number.

FACTORY SETTING	
2ND LEVEL	3RD LEVEL
Are you sure?	NO
	Yes

- 1) **Factory Setting:** Selecting YES will reset the unit's settings back to their factory defaults.

6.6 Basic AV Extension

6.6.1 Point-to-Point (One Way)

The most basic extension configuration available is a point-to-point system with a single transceiver unit acting as a transmitter connected directly to a single transceiver unit acting as a receiver. In this configuration the HDMI/DP input on the transmitter side is transmitted to the connected receiver side without modification to the audio or video format. The analog stereo audio input on the transmitter transfers audio directly to the analog stereo audio output on the receiver. The LAN, RS-232 and IR ports form direct connections between transmitter and receiver as well. This configuration is ideal for basic video extension as well as remote KVM applications.

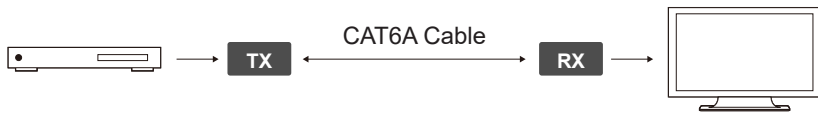

Note: This configuration does not use or require an external control center such as the IP Master Controller to function. No audio insertion/extraction is performed in this configuration.

6.6.2 Point-to-Point (Bi-directional)

Another basic extension configuration is a bi-directional point-to-point system with the transceiver units at each end acting as both transmitter and receiver. In this configuration the HDMI/DP input on each side is transmitted to the opposite end of the connection for output without modification to the audio or video format. The analog audio, LAN, RS-232 and IR ports form direct connections between both ends as well. This configuration is ideal for long distance, secure, fixed-point video conferencing applications.

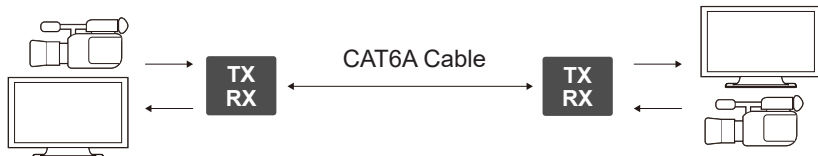

Note: This configuration does not use or require an external control center such as the IP Master Controller to function. No audio insertion/extraction is performed in this configuration.

7. CONNECTION DIAGRAM

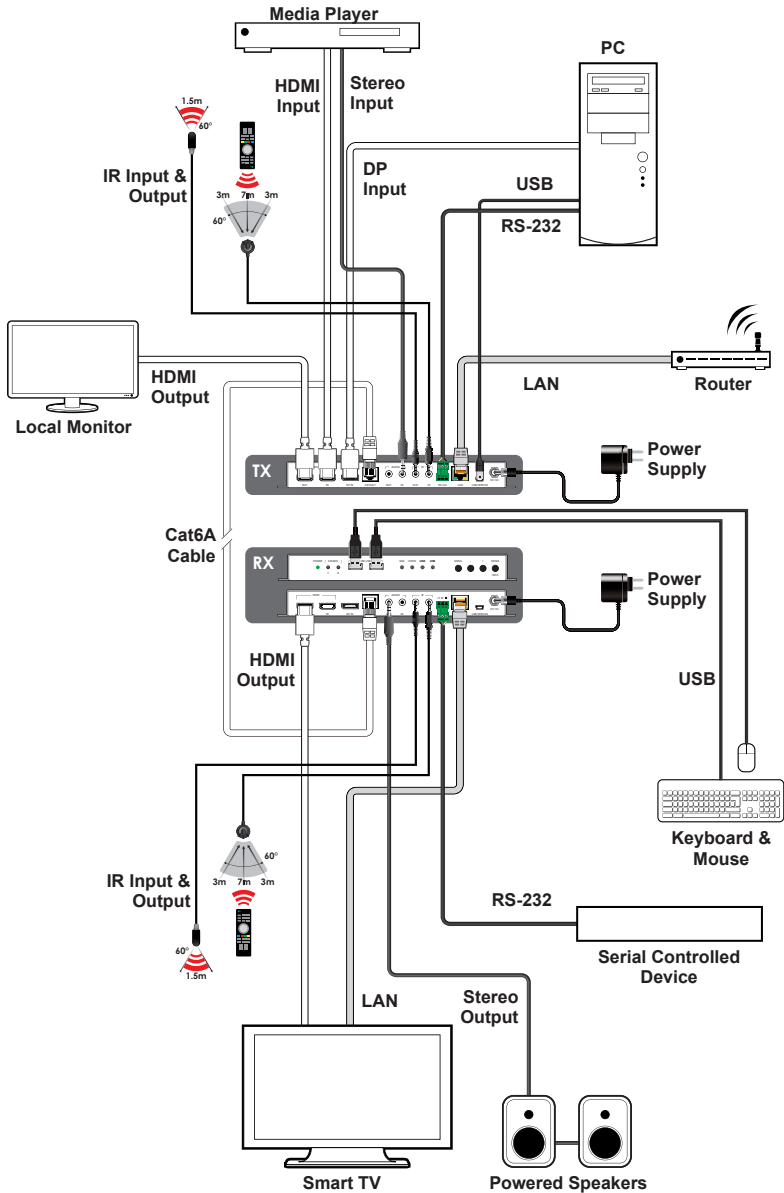

8. SPECIFICATIONS

8.1 Technical Specifications

HDMI Bandwidth	18Gbps
DisplayPort Bandwidth	21.6Gbps
CAT6A/7 Bandwidth	10Gbps
Input Ports	1×HDMI (Type-A) 1×DisplayPort 1×Stereo Audio (3.5mm)
Output Ports	1×HDMI (Type-A) 1×Stereo Audio (3.5mm)
Bi-directional Port	1×10GbE LAN (RJ-45)
Pass-through Ports	1×IR Extender (3.5mm) 1×IR Blaster (3.5mm) 1×RS-232 (3-pin Terminal Block) 2×USB (Type-A) 1×LAN (RJ-45)
Pass-through/Service Port	1×USB 2.0 (Mini-B)
IR Frequency	38kHz
Baud Rate	57600 (Default), up to 115200bps
Power Supply	12V/3A DC (US/EU standards, CE/FCC/UL certified)
ESD Protection (HBM)	±8kV (Air Discharge) ±4kV (Contact Discharge)
Dimensions (W×H×D)	215mm×25mm×108mm [Case Only] 215mm×25mm×116.7mm [All Inclusive]
Weight	916g
Chassis Material	Metal (Steel)
Chassis Color	Black
Operating Temperature	0°C – 40°C/32°F – 104°F
Storage Temperature	-20°C – 60°C/-4°F – 140°F
Relative Humidity	20 – 90% RH (Non-condensing)
Power Consumption	18.51W

8.2 Video Specifications

Supported Resolutions (Hz)	Input			Output	
	HDMI	DP	10GbE	HDMI	10GbE
720×400p@70/85	✓	✓	✓	✓	✓
640×480p@60/72/75/85	✓	✓	✓	✓	✓
720×480i@60	✓	✓	✓	✓	✓
720×480p@60	✓	✓	✓	✓	✓
720×576i@50	✓	✓	✓	✓	✓
720×576p@50	✓	✓	✓	✓	✓
800×600p@56/60/72/75/85	✓	✓	✓	✓	✓
848×480p@60	✓	✓	✓	✓	✓
1024×768p@60/70/75/85	✓	✓	✓	✓	✓
1152×864p@75	✓	✓	✓	✓	✓
1280×720p@50/60	✓	✓	✓	✓	✓
1280×768p@60/75/85	✓	✓	✓	✓	✓
1280×800p@60/75/85	✓	✓	✓	✓	✓
1280×960p@60/85	✓	✓	✓	✓	✓
1280×1024p@60/75/85	✓	✓	✓	✓	✓
1360×768p@60	✓	✓	✓	✓	✓
1366×768p@60	✓	✓	✓	✓	✓
1400×1050p@60	✓	✓	✓	✓	✓
1440×900p@60/75	✓	✓	✓	✓	✓
1600×900p@60RB	✓	✓	✓	✓	✓
1600×1200p@60	✓	✓	✓	✓	✓
1680×1050p@60	✓	✓	✓	✓	✓
1920×1080i@50/60	✓	✓	✓	✓	✓
1920×1080p@24/25/30	✓	✓	✓	✓	✓
1920×1080p@50/60	✓	✓	✓	✓	✓
1920×1200p@60RB	✓	✓	✓	✓	✓
2560×1440p@60RB	✓	✓	✓	✓	✓

Supported Resolutions (Hz)	Input			Output	
	HDMI	DP	10GbE	HDMI	10GbE
2560×1600p@60RB	✓	✓	✓	✓	✓
2048×1080p@24/25/30	✓	✓	✓	✓	✓
2048×1080p@50/60	✓	✓	✓	✓	✓
3840×2160p@24/25/30	✓	✓	✓	✓	✓
3840×2160p@50/60 (4:2:0)	✓	✓	✓	✓	✓
3840×2160p@24, HDR10	✓	✓	✓	✓	✓
3840×2160p@50/60 (4:2:0), HDR10	✓	✓	✓	✓	✓
3840×2160p@50/60	✓	✓	✓	✓	✓
4096×2160p@24/25/30	✓	✓	✓	✓	✓
4096×2160p@50/60 (4:2:0)	✓	✓	✓	✓	✓
4096×2160p@24, HDR10	✓	✓	✓	✓	✓
4096×2160p@50/60 (4:2:0), HDR10	✓	✓	✓	✓	✓
4096×2160p@50/60	✓	✓	✓	✓	✓

8.3 Audio Specifications

8.3.1 Digital Audio

HDMI Input / Output	
LPCM	
Max Channels	8 Channels
Sampling Rate (kHz)	32, 44.1, 48
Bitstream	
Supported Formats	Standard & High-Definition

DisplayPort Input	
LPCM	
Max Channels	8 Channels
Sampling Rate (kHz)	32, 44.1, 48
Bitstream	
Supported Formats	Standard & High-Definition

10GbE Input / Output	
LPCM	
Max Channels	8 Channels
Sampling Rate (kHz)	32, 44.1, 48
Bitstream	
Supported Formats	Standard & High-Definition

8.3.2 Analog Audio

Analog Input	
Max Audio Level	2Vrms
Impedance	10k Ω
Type	Unbalanced

Analog Output	
Max Audio Level	2Vrms
THD+N	< -80dB@0dBFS 1kHz (A-wt)
SNR	> 80dB@0dBFS
Frequency Response	< \pm 1dB@20Hz~20kHz
Crosstalk	< -80dB@10kHz
Impedance	470 Ω
Type	Unbalanced

8.4 Cable Specifications

Cable Length	1080p		4K30	4K60
	8-bit	12-bit	(4:4:4) 8-bit	(4:4:4) 8-bit
High Speed HDMI Cable				
HDMI Input	15m	10m	5m	3m
HDMI Output	15m	10m	5m	3m
DisplayPort Cable				
DisplayPort Input	15m	10m	2m	
Ethernet Cable				
Cat.6A/7	100m			

Bandwidth Category Examples:

- **1080p (FHD Video)**
 - Up to 1080p@60Hz, 12-bit color
 - Data rates lower than 5.3Gbps or below 225MHz TMDS clock
- **4K30 (4K UHD Video)**
 - 4K@24/25/30Hz & 4K@50/60Hz (4:2:0), 8-bit color
 - Data rates higher than 5.3Gbps or above 225MHz TMDS clock but below 10.2Gbps
- **4K60 (4K UHD⁺ Video)**
 - 4K@50/60Hz (4:4:4, 8-bit)
 - 4K@50/60Hz (4:2:0, 10-bit HDR)
 - Data rates higher than 10.2Gbps

9. ACRONYMS

ACRONYM	COMPLETE TERM
10GbE	10 Gigabit Ethernet
ADC	Analog-to-Digital Converter
AVoIP	Audio/Video over IP
Cat.5e	Enhanced Category 5 cable
Cat.6	Category 6 cable
Cat.6A	Augmented Category 6 cable
Cat.7	Category 7 cable
DAC	Digital-to-Analog Converter
dB	Decibel
DHCP	Dynamic Host Configuration Protocol
DP	DisplayPort
DVI	Digital Visual Interface
EDID	Extended Display Identification Data
GbE	Gigabit Ethernet
Gbps	Gigabits per second
GUI	Graphical User Interface
HDCP	High-bandwidth Digital Content Protection
HDMI	High-Definition Multimedia Interface
HDR	High Dynamic Range
HID	Human Interface Device
IEEE	Institute of Electrical and Electronics Engineers
IGMP	Internet Group Management Protocol
IP	Internet Protocol
IR	Infrared
kHz	Kilohertz
KVM	Keyboard/Video/Mouse
LAN	Local Area Network
LED	Light-Emitting Diode

ACRONYM	COMPLETE TERM
LPCM	Linear Pulse-Code Modulation
MAC	Media Access Control
MHz	Megahertz
OSD	On-Screen Display
PIP	Picture in Picture
PoE	Power over Ethernet
PoP	Picture outside of Picture
SDVoE	Software Defined Video over Ethernet
SNR	Signal-to-Noise Ratio
TCP	Transmission Control Protocol
THD+N	Total Harmonic Distortion plus Noise
TMDs	Transition-Minimized Differential Signaling
4K UHD	4K Ultra-High-Definition (10.2Gbps max)
4K UHD+	4K Ultra-High-Definition (18Gbps max)
USB	Universal Serial Bus
VGA	Video Graphics Array
VoIP	Video over IP
WUXGA (RB)	Widescreen Ultra Extended Graphics Array (Reduced Blanking)
XGA	Extended Graphics Array
Ω	Ohm



CYPRESS TECHNOLOGY CO., LTD.
www.cypress.com.tw
