



CDPW-K3US/K3EUK (-W)

8-Button Control Keypad
(1-Gang Box with US or EU/UK Faceplate
in White or Black)



Operation Manual

DISCLAIMERS

The information in this manual has been carefully checked and is believed to be accurate. Cypress Technology assumes no responsibility for any infringements of patents or other rights of third parties which may result from its use.

Cypress Technology assumes no responsibility for any inaccuracies that may be contained in this document. Cypress also makes no commitment to update or to keep current the information contained in this document.

Cypress Technology reserves the right to make improvements to this document and/or product at any time and without notice.

COPYRIGHT NOTICE

No part of this document may be reproduced, transmitted, transcribed, stored in a retrieval system, or any of its part translated into any language or computer file, in any form or by any means—electronic, mechanical, magnetic, optical, chemical, manual, or otherwise—without express written permission and consent from Cypress Technology.

© Copyright 2018 by Cypress Technology.

All Rights Reserved.

TRADEMARK ACKNOWLEDGMENTS

All products or service names mentioned in this document are trademarks of the companies with which they are associated.



SAFETY PRECAUTIONS

Please read all instructions before attempting to unpack, install or operate this equipment and before connecting the power supply. Please keep the following in mind as you unpack and install this equipment:

- Always follow basic safety precautions to reduce the risk of fire, electrical shock and injury to persons.
- To prevent fire or shock hazard, do not expose the unit to rain, moisture or install this product near water.
- Never spill liquid of any kind on or into this product.
- Never push an object of any kind into this product through any openings or empty slots in the unit, as you may damage parts inside the unit.
- Do not attach the power supply cabling to building surfaces.
- Use only the supplied power supply unit (PSU). Do not use the PSU if it is damaged.
- Do not allow anything to rest on the power cabling or allow any weight to be placed upon it or any person walk on it.
- To protect the unit from overheating, do not block any vents or openings in the unit housing that provide ventilation and allow for sufficient space for air to circulate around the unit.
- Please completely disconnect the power when the unit is not in use to avoid wasting electricity.

VERSION HISTORY

REV.	DATE	SUMMARY OF CHANGE
RDV1	2021/06/10	Preliminary release
RDV2	2022/01/03	Power adapter removed from package contents
RDV3	2023/01/17	Add condition console commands

CONTENTS

1. Introduction	1
2. Applications	1
3. Package Contents	1
4. System Requirements	2
5. Features	2
6. Operation Controls and Functions	3
6.1 Front Panel.....	3
6.2 Rear and Side Panel	4
6.3 Physical Installation.....	5
6.4 WebGUI Control	6
6.4.1 Macro Settings Tab.....	8
6.4.2 Extension Macro 1-3 Tab.....	12
6.4.3 Command Settings Tab	13
6.4.4 Device Settings Tab.....	15
6.4.5 Message Polling Tab	16
6.4.6 Key Settings Tab	18
6.4.7 Schedule Tab.....	19
6.4.8 Condition Tab	22
6.4.9 User Config Tab.....	22
6.4.10 Network Settings Tab	23
6.4.11 System Settings Tab.....	24
6.4.12 Time Settings Tab.....	25
6.5 Telnet Control	26
6.6 Serial and Telnet Commands	26
7. Connection Diagram	32
8. Specifications	33
8.1 Technical Specifications (US/US-W)	33
8.2 Technical Specifications (EUK/EUK-W).....	34
9. Acronyms	35



1. INTRODUCTION

This keypad is a versatile and useful product for both system integrators and smart home users alike. This keypad can send commands to any Ethernet controlled device in your system. With 8 physical macro buttons and up to an additional 24 software macro buttons you can program and recall up to 32 distinct macros providing for complete control over your audio and video environment. The subtle, yet colorful, LED buttons are suitable for all environments and PoE (Power over Ethernet) support allows for creative placement of the keypad within your space without needing to be concerned about keeping it near a live power source. Additionally, the integrated clock and calendar based scheduling feature allows you to trigger macros to control devices within your installation at a specific time, or on a recurring schedule. Primary control is via a comprehensive WebGUI interface with additional control via Telnet commands.

2. APPLICATIONS

- Smart Home Control
- Control Center
- Function Room
- Product Showroom
- Ballroom

3. PACKAGE CONTENTS

- 1× 8-Button Control Keypad
- 1× 1-Gang Wall Plate (US or EU/UK, White or Black)
- 1× Operation Manual

4. SYSTEM REQUIREMENTS

- An active Internet connection from a switch or router for control of Ethernet devices.
- A PoE supporting network switch or hub is required to use the PoE power function, otherwise access to a local power outlet is needed.

5. FEATURES

- 1-Gang (US or EU/UK) wall plate design with tri-color LED buttons
- 32 macros for controlling user equipment
- Up to 128 total commands can be stored and used across all macros in the system (up to 16 per macro)
- Supports time and date macro scheduling (single and recurring)
- Supports condition checking within macro commands for expanded macro design flexibility
- Supports one month of backup power for the internal clock and schedule function to protect against blackouts and temporary power loss
- Supports customizable daylight savings time configuration
- Can be powered by an Ethernet switch that supports the IEEE 802.3af PoE standard
- Controllable via keypad, Telnet and WebGUI

6. OPERATION CONTROLS AND FUNCTIONS

6.1 Front Panel

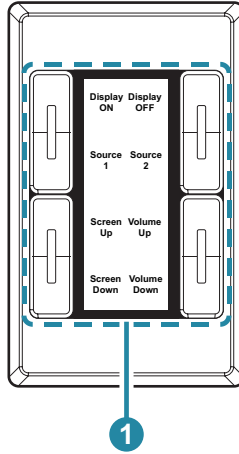

- 1 KEY 1~8 Buttons:** Each button activates the customizable macro that has been assigned to it. Each button contains a trio of individually controllable colored LEDs (red, green, and blue).

Note: Further details on macro configuration settings please refer to section 6.4.1.

6.2 Rear and Side Panel

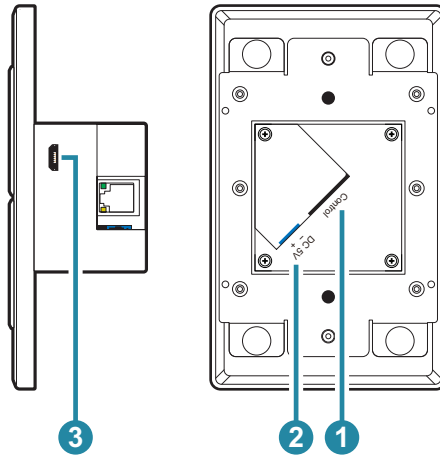

- 1 **CONTROL Port:** Connect to an active Ethernet network via a switch or router to allow it to control other devices on the network and to be accessed via Telnet/WebGUI.

Note: If the connected network switch supports the IEEE 802.3af PoE (Power over Ethernet) standard, this unit can optionally be powered directly via this Ethernet connection.

- 2 **DC 5V 2-pin Terminal Block:** Plug the 5V DC power adapter into this port and connect it to an AC wall outlet for power.

Note: Optional, not required if the unit is powered via PoE.

- 3 **Micro USB Port:** This port is reserved for firmware update use only.

6.3 Physical Installation

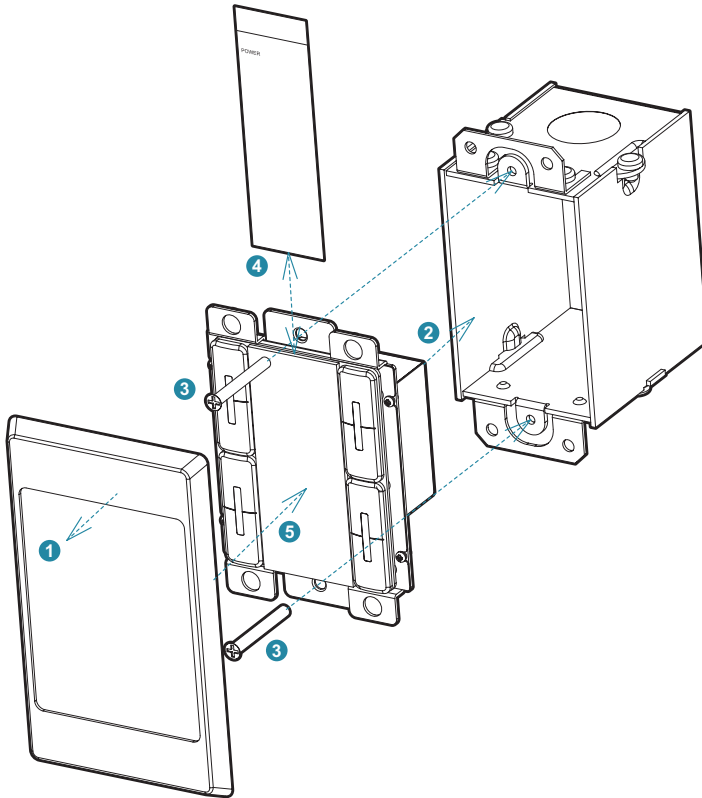

- 1** Remove the decorative faceplate from the front of the unit by pulling on it.
Note: The faceplate is held in place by 4 magnets.
- 2** Place the unit into a US 2-gang electrical wall box (not included) and ensure that all necessary cabling (Ethernet, power) is properly fed through the back access holes in the wall box and connected to the back of the unit.
- 3** Secure the unit in place with appropriate mounting screws. Typically these are supplied with the electrical wall box.
- 4** Reattach the decorative faceplate to the front of the unit.
Note: Faceplate will be a different size for the EU/UK version, but assembly is the same.

6.4 WebGUI Control

• Device Discovery

Please obtain the “Device Discovery” software from your authorized dealer and save it in a directory where you can easily find it.

Connect the unit and your PC/Laptop to the same active network and execute the “Device Discovery” software. Click on “Find Devices on Internet” and a list of devices connected to the local network will show up indicating their current IP address.

Note: This unit defaults to DHCP mode.

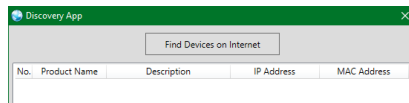

By clicking on one of the listed devices you will be presented with the network details of that particular device.

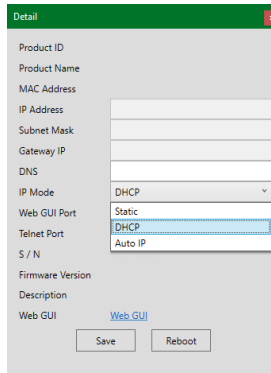

- 1) **IP Mode:** If you choose, you can alter the static IP network settings for the device, or switch the unit into DHCP mode to automatically obtain proper network settings from a local DHCP server. To switch to DHCP mode, please select DHCP from the IP mode drop-down, then click “Save” followed by “Reboot”.
- 2) **WebGUI Hotkey:** Once you are satisfied with the network settings, you may use them to connect via Telnet or WebGUI. The network information window provides a convenient link to launch the WebGUI directly.

- **WebGUI Overview**

After connecting to the WebGUI's address in a web browser, the login screen will appear. Please enter the appropriate user name and password then click "Submit" to log in.

Note: The default user name and password is "admin".

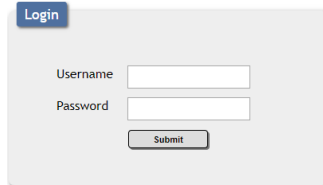

A login form with a blue "Login" button at the top left. Below it are two input fields: "Username" and "Password". At the bottom center is a "Submit" button.

On the left side of the browser you will see the following menu tabs where all primary functions of the unit are controllable via the built in WebGUI. The individual functions will be introduced in the following sections.

- Macro Settings
- Extension Macro 1
- Extension Macro 2
- Extension Macro 3
- Command Settings
- Device Settings
- Message Polling
- Key Settings
- Schedule
- Condition
- User Config
- Network Settings
- System Settings
- Time Settings
- Admin - Logout**

Clicking the red "Logout" tab will automatically log the currently connected user out of the WebGUI and return to login page.

6.4.1 Macro Settings Tab

This tab provides a way to execute/edit the settings for the unit's physical macro buttons. These macros can be executed by pressing the physical buttons on the keypad as well as via the WebGUI or Telnet. Control over the LED Demo Mode is also provided here.

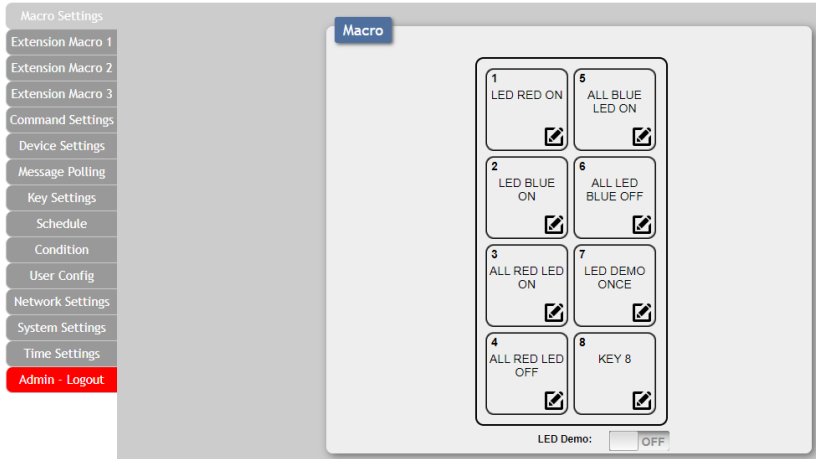

- 1) **Macro Buttons:** Press any of these buttons to activate the macro currently stored within it. Hovering the mouse over a button will list its current macro contents. Click on the edit icon () to edit each button's macro.
- 2) **LED Demo:** This switch enables or disables the LED Demo Mode. When Demo Mode is active, the unit will automatically turn the LEDs on and off in various patterns.

Note: LED Demo Mode is off by default.

- 3) **Macro Edit:** Click on any button's edit icon () to edit that button's macro. The Macro Edit window displays the full contents of the macro including its name as well as each command's communication interface to use with its associated parameters, delay time before executing the next command, and conditional execution requirements. The order of command execution is from top to bottom. When you have finished editing the macro click on "Save Change".

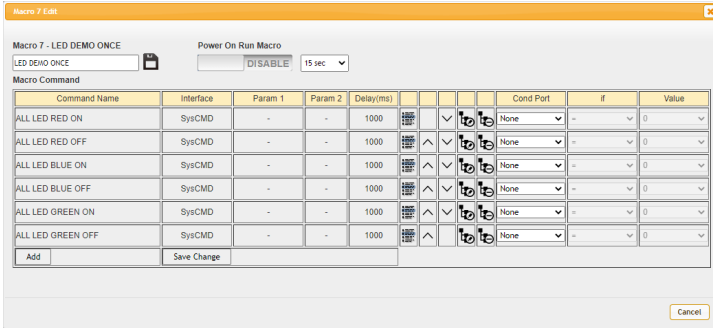

- **Edit Macro Name:** At the top of the Macro edit window is a text field where you can edit the name of the macro. Type your new macro name into the box and then click the disc icon (💾) to save it.
- **Power On Run Macro:** Enable or disable this macro being automatically executed every time unit powers on. An execution start delay must also be set, using the dropdown, with a range from 1 to 240 seconds.
- **Add Command:** Click on the command icon (⊞) to insert a new command before the current one or click on the “Add” button to add a command to the end of the list. Select one of the pre-defined commands from the provided list.



After selecting a command, you will need to choose the delay and interface for the command.

Note: Details on how to create these pre-defined commands are provided in section 6.4.3.

- **Change Command Order:** Within the edit window clicking on the up/down arrows will change the execution order of each command.
- **Set Destination:** Clicking on the edit destination icon (🔗) allows you to edit the post-execution delay value as well as set the interface and all associated settings for that command.

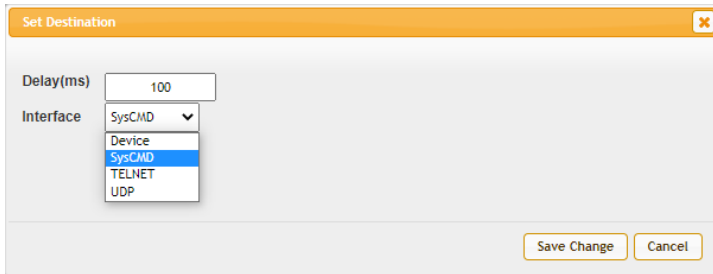

The image shows a dialog box titled "Set Destination" with a close button (X) in the top right corner. It contains two main sections: "Delay(ms)" and "Interface".

- The "Delay(ms)" section has a text input field containing the value "100".
- The "Interface" section has a dropdown menu currently showing "SysCMD". The dropdown is open, showing a list of options: "Device", "SysCMD" (highlighted in blue), "TELNET", and "UDP".

At the bottom right of the dialog box, there are two buttons: "Save Change" and "Cancel".

The “Delay(ms)” setting is the length of time to wait before sending the next command and is set in milliseconds. The interface for sending commands can be set, using the dropdown, to predefined Ethernet devices (Device), to the Keypad itself (SysCMD), or to a specified IP address using the Telnet or UDP protocols.

Sending commands to devices on the local network, or across the Internet requires the IP address and network port number of the destination device. Once the destination information is complete please click on “Save Change”.

Note: It is strongly suggested to not set a delay time less than 100ms for system commands or less than 500ms for Telnet commands to ensure that the command is properly received and executed before the next command is sent.

- **Remove Command:** Clicking on the delete command icon (🗑️) will remove that command from the execution list.
- **Execution Condition:** Use the dropdowns to set a specific condition for each step in the macro to execute or not. If an execution condition tests as “false” when it is time to execute that command, then that step of the macro will be skipped. Selecting “None” means the macro command will always be executed.

Cond Port	if	Value
1	=	0
None	>	0
None	>=	0
None	<	0
None	<=	0
None	!=	0

To configure a condition test, select the Condition Port to read a value from, select a logical comparison expression, and then select a static value to use for the comparison.

For example, if the following choices are made:

Cond Port [1], If [=], Value [0]

Then the unit will check the value of Condition Port #1 and if the value stored there equals “0” then the test will return “true” and the macro step will execute. If the stored value is any other number, it will return “false” and the macro step will be skipped.

6.4.2 Extension Macro 1-3 Tab

The three “Extension Macro” tabs provide a way to execute/edit the additional software-only macro buttons. These macros can only be executed via the WebGUI or Telnnet. Macro activation and editing in these tabs is identical to the Macro Settings tab.

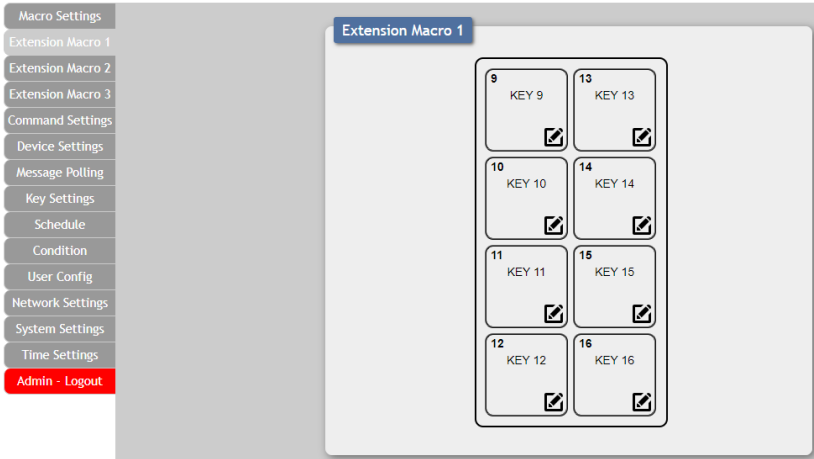

6.4.3 Command Settings Tab

This tab provides a way to create, edit, or delete commands. The number of commands that can be stored in the keypad is limited by memory. It is generally recommended that commands be under 128 characters long (including spaces). However, if longer commands are needed there is limited support for commands up to 512 characters long. The number of (up to) 512 character commands is limited to 32 and the remaining 96 commands must be under 128 characters.

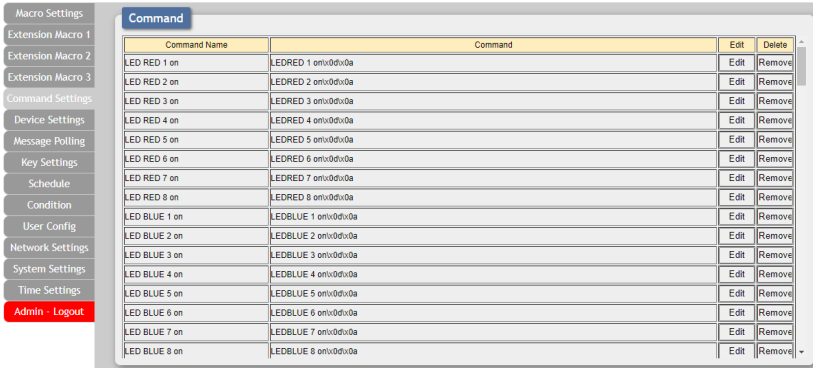

The screenshot shows a web interface with a sidebar menu on the left and a main content area. The sidebar menu includes items like 'Macro Settings', 'Extension Macro 1', 'Command Settings', and 'Admin - Logout'. The main content area is titled 'Command' and contains a table with columns for 'Command Name', 'Command', 'Edit', and 'Delete'.

Command Name	Command	Edit	Delete
LED RED 1 on	LEDRED 1 oniv0dv0a	Edit	Remove
LED RED 2 on	LEDRED 2 oniv0dv0a	Edit	Remove
LED RED 3 on	LEDRED 3 oniv0dv0a	Edit	Remove
LED RED 4 on	LEDRED 4 oniv0dv0a	Edit	Remove
LED RED 5 on	LEDRED 5 oniv0dv0a	Edit	Remove
LED RED 6 on	LEDRED 6 oniv0dv0a	Edit	Remove
LED RED 7 on	LEDRED 7 oniv0dv0a	Edit	Remove
LED RED 8 on	LEDRED 8 oniv0dv0a	Edit	Remove
LED BLUE 1 on	LEDBLUE 1 oniv0dv0a	Edit	Remove
LED BLUE 2 on	LEDBLUE 2 oniv0dv0a	Edit	Remove
LED BLUE 3 on	LEDBLUE 3 oniv0dv0a	Edit	Remove
LED BLUE 4 on	LEDBLUE 4 oniv0dv0a	Edit	Remove
LED BLUE 5 on	LEDBLUE 5 oniv0dv0a	Edit	Remove
LED BLUE 6 on	LEDBLUE 6 oniv0dv0a	Edit	Remove
LED BLUE 7 on	LEDBLUE 7 oniv0dv0a	Edit	Remove
LED BLUE 8 on	LEDBLUE 8 oniv0dv0a	Edit	Remove

- 1) **Command Edit:** To edit or create a new command, click on the “Edit” button. The name of the command and its text contents can be entered here.

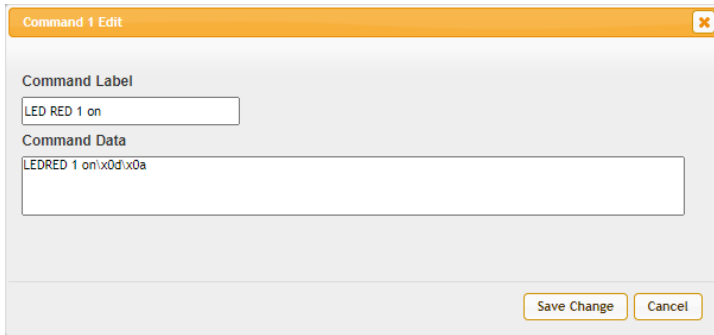

- **Condition Port Values:** Values that are stored within one of the unit’s 64 Condition Ports can be inserted into a command by using the escape sequence format “\cN1N2” where N1 is the 2-digit Condition Port number and N2 defines the preferred formatting of the value using the common C++ “%” string formatting style (%d, %x, etc.).
- **Special Characters:** Special control characters that can’t normally be typed should be entered using their ASCII hex value preceded by the “\x” escape sequence. For example, a carriage return and linefeed would be entered as: “\x0d\x0a”. Click on “Save Change” to save the command.
- **SYS Commands:** Any of the unit’s own Telnet commands can be used as commands within a macro to directly control the unit’s features such as LED Mode, etc.
Note: To use these the command interface must be set to SysCMD when creating the macro.

- 2) **Command Delete:** To completely remove a command from the unit, click on the “Remove” button next to the command.

Note: If the deleted command was used in any macros, it will be removed from them as well.

6.4.4 Device Settings Tab

This tab provides controls to enable/disable or add/remove standard network connected devices to be used as the interface target for a macro command. Up to 16 devices can be defined for easy use with commands. The name of each device can be up to 24 characters long (spaces are not allowed). A valid IP address and network port are required for each device. These settings are directly linked to any associated macro commands.

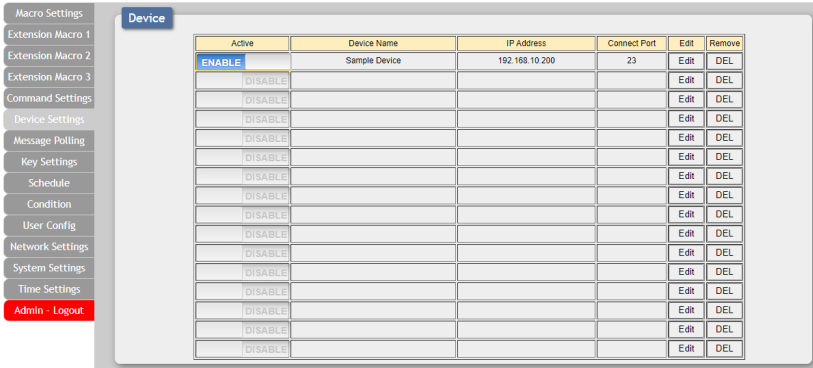

Active	Device Name	IP Address	Connect Port	Edit	Remove
ENABLE	Sample Device	192.168.10.200	23	Edit	DEL
DISABLE				Edit	DEL
DISABLE				Edit	DEL
DISABLE				Edit	DEL
DISABLE				Edit	DEL
DISABLE				Edit	DEL
DISABLE				Edit	DEL
DISABLE				Edit	DEL
DISABLE				Edit	DEL
DISABLE				Edit	DEL
DISABLE				Edit	DEL
DISABLE				Edit	DEL
DISABLE				Edit	DEL
DISABLE				Edit	DEL
DISABLE				Edit	DEL
DISABLE				Edit	DEL

- 1) **Active:** Once a device has been defined, it can be enabled or disabled as an available target device by clicking on the button.
- 2) **Edit Device:** Clicking on the “Edit” button opens up the Edit Device window. Here the target device’s name, IP address and Telnet port can be set. Click on “Save Change” to save the device’s configuration.

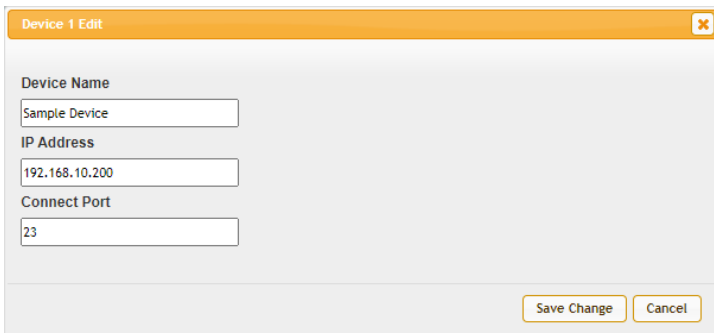

Device 1 Edit
✕

Device Name

IP Address

Connect Port

- Remove Device:** To completely remove a device definition from the unit, click on the “DEL” button next to the device.

Note: If a deleted device was used as the target of any commands in a macro, those command entries will automatically be removed from the macros as well.

6.4.5 Message Polling Tab

This tab provides controls to enable/disable or add/remove Polling Command events. Up to 16 Polling events can be defined. Polling Command events are used to check the current status of various functions on Ethernet based remote devices, typically to verify power or selection status for the purpose of changing LED colors or setting Condition Port values.

Note: Polling events operate on independent timers once enabled.

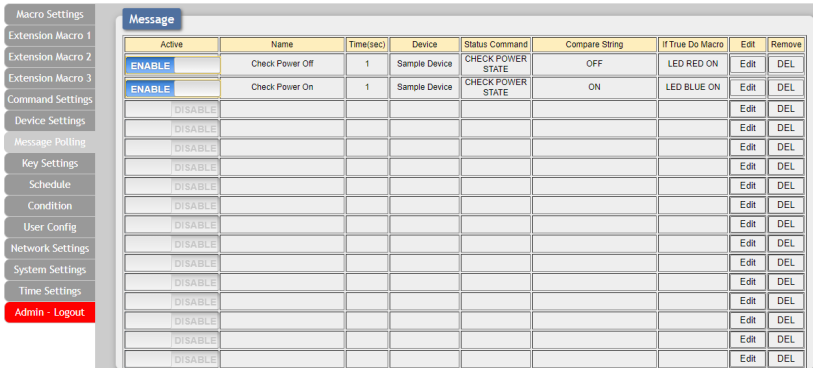

Active	Name	Time(sec)	Device	Status Command	Compare String	If True Do Macro	Edit	Remove
ENABLE	Check Power Off	1	Sample Device	CHECK POWER STATE	OFF	LED RED ON	Edit	DEL
ENABLE	Check Power On	1	Sample Device	CHECK POWER STATE	ON	LED BLUE ON	Edit	DEL
DISABLE							Edit	DEL
DISABLE							Edit	DEL
DISABLE							Edit	DEL
DISABLE							Edit	DEL
DISABLE							Edit	DEL
DISABLE							Edit	DEL
DISABLE							Edit	DEL
DISABLE							Edit	DEL
DISABLE							Edit	DEL
DISABLE							Edit	DEL
DISABLE							Edit	DEL
DISABLE							Edit	DEL
DISABLE							Edit	DEL

- Active:** Once a Polling Command has been defined, it can be enabled or disabled by clicking on the “Enable/Disable” button.
- Edit Polling:** Clicking on the “Edit” button opens up the Edit Polling window. Here the Polling Command’s full configuration can be set. Click on “Save Change” to save the Polling Command’s configuration.

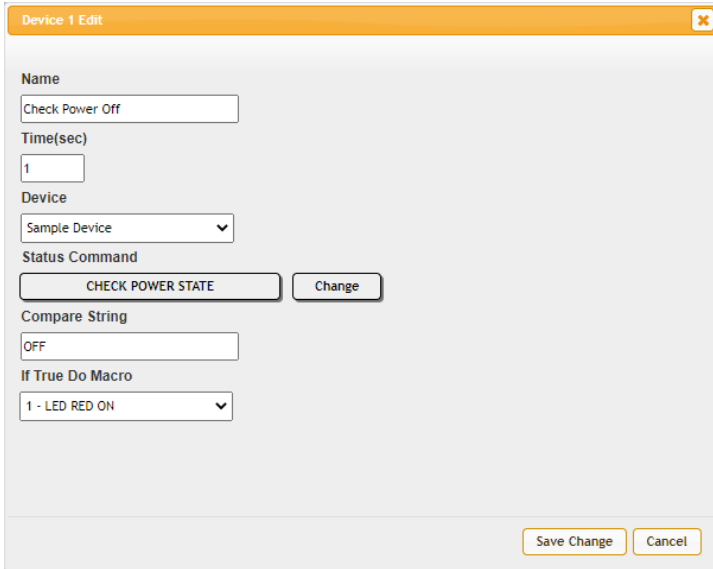

- **Name:** Enter a name for this Polling Command.
 - **Time(sec):** Enter the time interval to wait, in seconds, between polling transmissions. The minimum wait time is 1 second.
 - **Device:** Use the dropdown to select a pre-defined target Device to send the Polling Command to.
 - **Status Command:** Click on the “Change” button to select a predefined Command from the provided list. This command will be sent to the target Device at the defined interval.
 - **Compare String:** Enter a text string to compare against the result returned by the Status Command.
 - **If True Do Macro:** Use the dropdown menu to select a preconfigured macro. If the polling comparison returns a “true” result, run this macro.
- 3) **Remove Polling:** To completely remove a Polling Command from the unit, click on the “DEL” button next to it.

6.4.6 Key Settings Tab

This tab provides controls to enable/disable the “Repeat” and “Toggle” modes associated with each of the unit’s physical macro buttons.

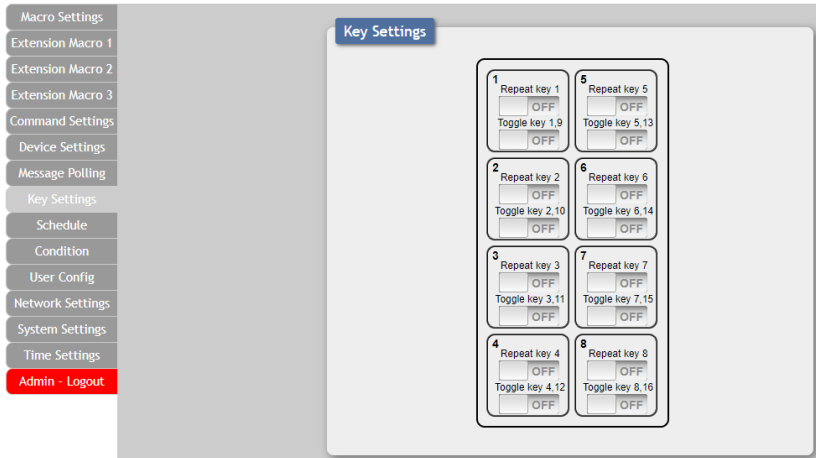

- 1) **Repeat Key:** Enabling this mode will cause the button’s macro to be executed repeatedly as long as the button is being held down.
- 2) **Toggle Key:** Enabling this mode will link the two listed macros together and allow them to be toggled back and forth each time the associated button is pressed.

6.4.7 Schedule Tab

This tab provides options to control the built in scheduling features of the keypad. You can set macro events to repeat on a regular daily/weekly schedule or configure a one-time event on a specific date. Events can be edited and deleted from the main tab by clicking on the appropriate button. The system can store up to 32 repeating events and up to 8 one-time events.

Note: Each scheduled item must be set as “Active” for it to activate at the scheduled time.

- Macro Settings
- Extension Macro 1
- Extension Macro 2
- Extension Macro 3
- Command Settings
- Device Settings
- Message Polling
- Key Settings
- Schedule
- Condition
- User Config
- Network Settings
- System Settings
- Time Settings
- Admin - Logout

Schedule

Repeat

Active	Weekly	Hour	Minute	Second	Macro	Edit	Delete
V	Mon,Wed,Fri	16	29	11	LED DEMO ONCE	Edit	Remove
	Tue,Thu	05	29	39	ALL RED LED OFF	Edit	Remove
		00	00	00		Edit	Remove
		00	00	00		Edit	Remove
		00	00	00		Edit	Remove

Once

Active	Month	Date	Hour	Minute	Second	Macro	Edit	Delete
V	03	16	16	30	00	ALL BLUE LED ON	Edit	Remove
	00	00	00	00	00		Edit	Remove
	00	00	00	00	00		Edit	Remove
	00	00	00	00	00		Edit	Remove
	00	00	00	00	00		Edit	Remove
	00	00	00	00	00		Edit	Remove

1) **Schedule Repeat:** Items in this section will execute at their set times on the selected days (Sunday through Saturday) every week as long as they are marked as “Active”. “Repeat” events can be edited and deleted from by clicking on the appropriate button. Click on “Save Change” to save the changes to the scheduled event.

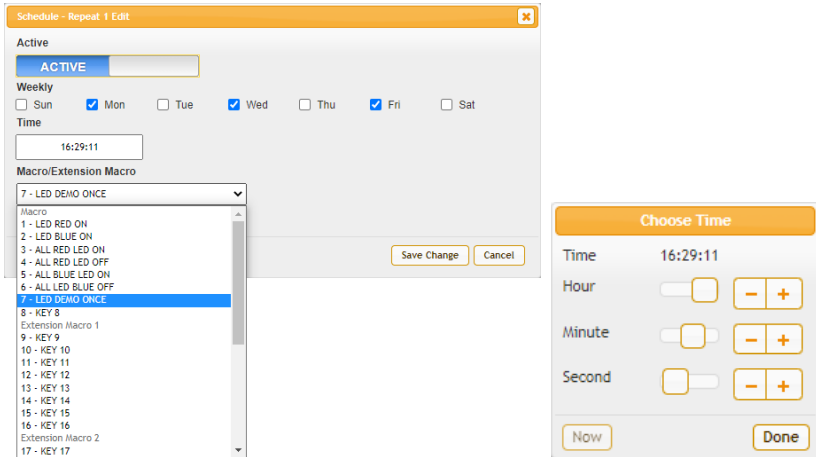

- **Active:** Click this to toggle if the scheduled event is active or disabled.
- **Weekly:** Select the days of the week that the event should be executed on, when active.
- **Time:** Set the time that the event should begin execution on all selected days, when active.
- **Macro/Extension Macro:** Use the dropdown to select the Macro or Extension Macro to execute.

- 2) **Schedule Once:** Items in this section are scheduled to occur a single time at the specified time and date. Each item will automatically change to “None Active” after they have been executed once. “Once” events can be edited and deleted from by clicking on the appropriate button. Click on “Save Change” to save the changes to the scheduled event.

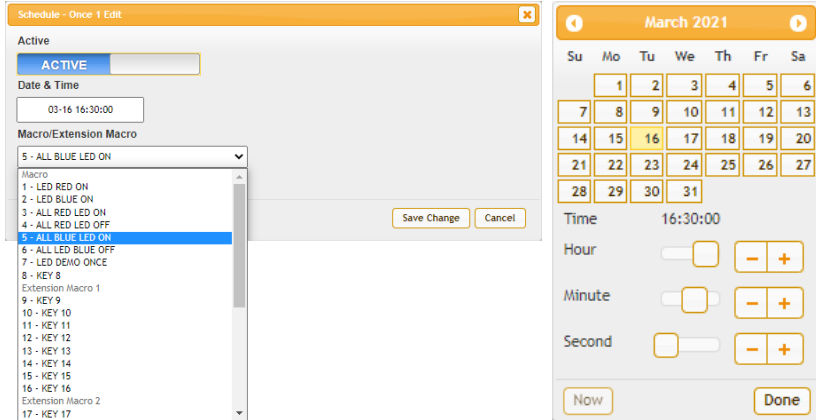

The screenshot shows the 'Schedule - Once 1 Edit' window. The 'Active' section has a toggle switch labeled 'ACTIVE'. The 'Date & Time' section shows '03-16 16:30:00'. The 'Macro/Extension Macro' section has a dropdown menu with '5 - ALL BLUE LED ON' selected, and a list of macros and extension macros below it. To the right is a calendar for March 2021 with a date picker set to the 16th. Below the calendar are time selection controls for Hour, Minute, and Second, with a 'Now' button and a 'Done' button.

- **Active:** Click this to toggle if the scheduled event is active or disabled.
- **Date & Time:** Click within the Time/date box to open up the time/date selection window. Use the available controls to set the activation time and date for the current event schedule.
- **Macro/Extension Macro:** Use the dropdown to select the Macro or Extension Macro to execute.

6.4.8 Condition Tab

This tab displays the current contents of all 64 Condition Ports and is for information display only.

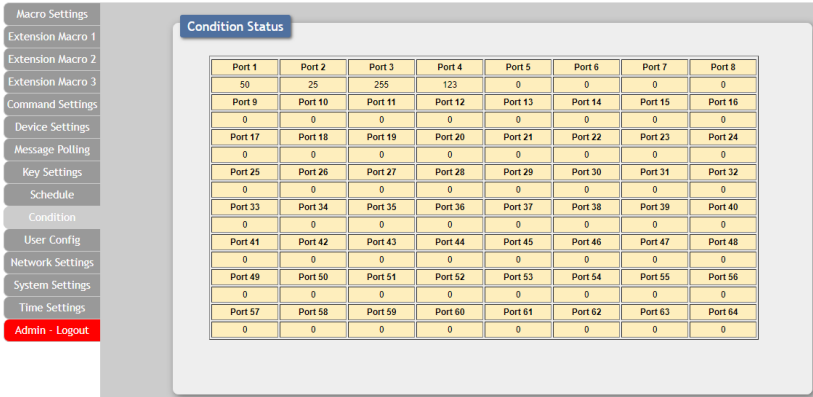

Port 1	Port 2	Port 3	Port 4	Port 5	Port 6	Port 7	Port 8
50	25	255	123	0	0	0	0
Port 9	Port 10	Port 11	Port 12	Port 13	Port 14	Port 15	Port 16
0	0	0	0	0	0	0	0
Port 17	Port 18	Port 19	Port 20	Port 21	Port 22	Port 23	Port 24
0	0	0	0	0	0	0	0
Port 25	Port 26	Port 27	Port 28	Port 29	Port 30	Port 31	Port 32
0	0	0	0	0	0	0	0
Port 33	Port 34	Port 35	Port 36	Port 37	Port 38	Port 39	Port 40
0	0	0	0	0	0	0	0
Port 41	Port 42	Port 43	Port 44	Port 45	Port 46	Port 47	Port 48
0	0	0	0	0	0	0	0
Port 49	Port 50	Port 51	Port 52	Port 53	Port 54	Port 55	Port 56
0	0	0	0	0	0	0	0
Port 57	Port 58	Port 59	Port 60	Port 61	Port 62	Port 63	Port 64
0	0	0	0	0	0	0	0

6.4.9 User Config Tab

This tab provides User Configuration options including changing the password for the Administrator account, and both the user name and password for the General User account.

Note: The default Administrator username and password is “admin”. The default General User username and password is “user”.

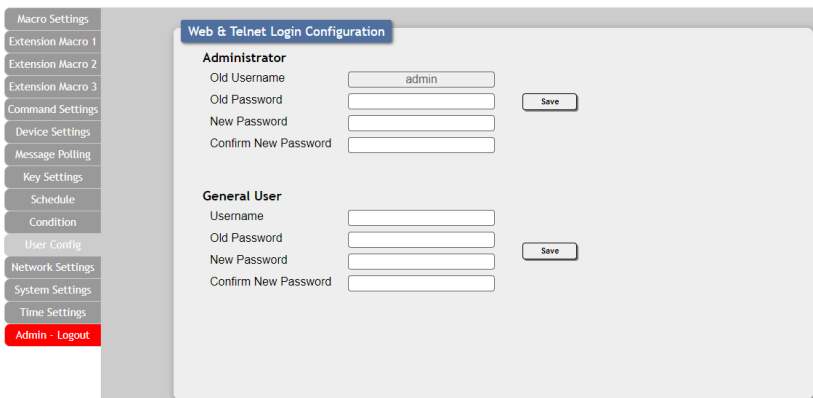

Web & Telnet Login Configuration

Administrator

Old Username:

Old Password:

New Password:

Confirm New Password:

General User

Username:

Old Password:

New Password:

Confirm New Password:

Note: The General User account has limited access to the WebGUI and can only activate pre-configured Macro and Extension Macro buttons.

6.4.10 Network Settings Tab

This tab provides controls to change the network settings for the unit. You can manually set the IP address, netmask and gateway address in “Static IP” mode, or you can obtain an IP address automatically by enabling DHCP.

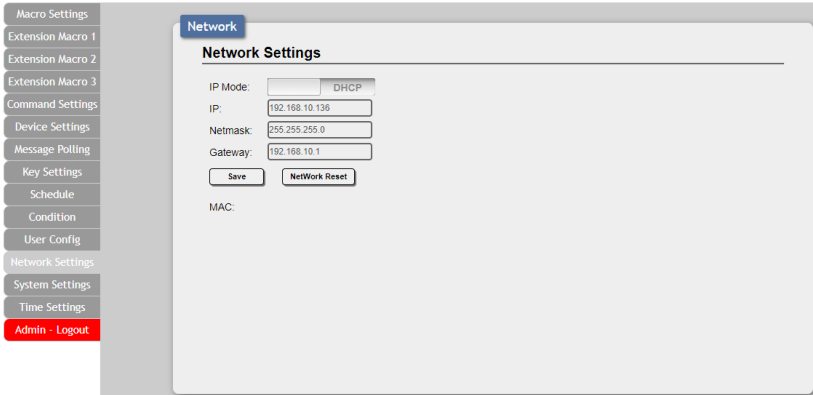

The screenshot shows the 'Network Settings' configuration page. On the left is a vertical navigation menu with items: Macro Settings, Extension Macro 1, Extension Macro 2, Extension Macro 3, Command Settings, Device Settings, Message Polling, Key Settings, Schedule, Condition, User Config, Network Settings (highlighted), System Settings, Time Settings, and Admin - Logout. The main panel is titled 'Network Settings' and includes a radio button for 'IP Mode' with 'Static IP' selected and 'DHCP' unselected. Below are input fields for 'IP:' (192.168.10.136), 'Netmask:' (255.255.255.0), and 'Gateway:' (192.168.10.1). At the bottom of these fields are 'Save' and 'Network Reset' buttons. A 'MAC:' label is positioned below the gateway field.

- 1) **Network Settings:** IP mode may be switched between Static IP or DHCP. In Static IP mode the IP, netmask and gateway addresses may be manually set. When in DHCP mode, the unit will attempt to connect to a local DHCP server and obtain IP, netmask and gateway addresses automatically. Please press “Save” after making any changes to the IP configuration or mode. To return all network settings to their defaults, press the “Network Reset” button.

Note: By default the IP mode is set to DHCP. If the IP address is changed then the IP address required for WebGUI/Telnet access will also change accordingly.

6.4.11 System Settings Tab

This tab provides controls to make changes to various system settings.

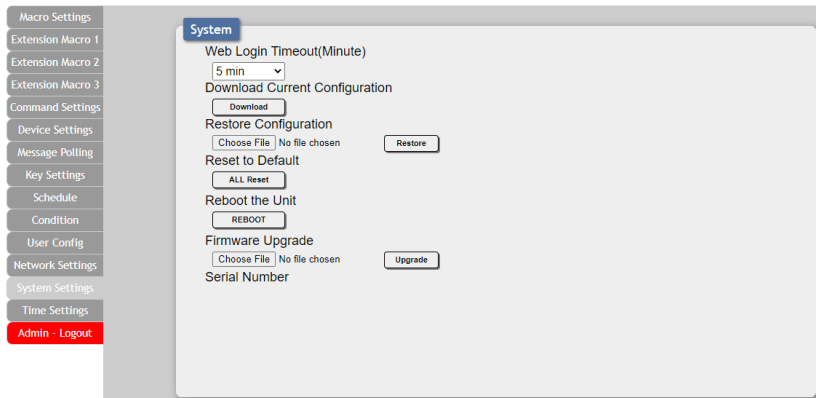

- 1) **Web Login Timeout:** Set the length of time, in minutes, to wait before logging the user out of the WebGUI due to inactivity. This can be set from 0 (No timeout) to 60 minutes.
- 2) **Download Current Configuration:** The current system configuration, including routing and settings, may be saved as an XML file to a PC. Click the “Download” button to save the current system configuration to your local PC. This file will also include all macros, commands, and scheduled events.
- 3) **Restore Configuration:** Previously saved system configurations may be restored from a saved XML file. Click the “Choose File” button to locate the saved XML file, then click the “Restore” button.
- 4) **Reset to Default:** Press the “ALL Reset” button to reset the unit to its factory default state. After the reset is complete, the unit will reboot automatically.
Note: All customized macros, commands, and scheduled events will also be reset to their factory defaults.
- 5) **Reboot the Unit:** Click this button to manually reboot the unit.
- 6) **Firmware Upgrade:** To update the unit’s firmware, click the “Choose File” button to open the file selection window and then select the firmware update file (*.bin format) located on your local PC. After selecting the file, click the “Upgrade” button to begin the firmware update process. After the upgrade is complete, the unit will reboot automatically.
- 7) **Serial Number:** Displays the unit’s serial number.

6.4.12 Time Settings Tab

This tab provides controls to set the system's time, date, and time zone. After setting the system time, the unit will maintain the correct time, even when powered off, due to a battery backed up clock. If your country uses DST (Daylight Saving Time) you can enable or disable it here and configure the start and end times/dates so that your scheduled events will always occur at the correct times throughout the year.

Note: This unit has one month of backup power for the internal clock to protect against power loss and blackouts. After the backup power is exhausted the system time will reset back to 2021/01/01 00:00:00.

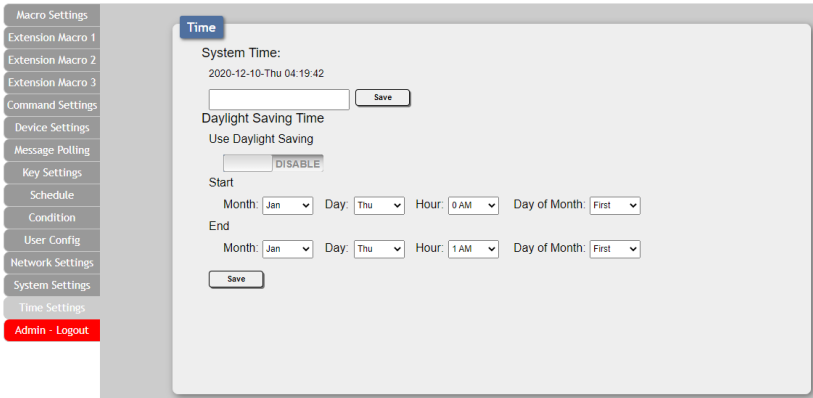

- 1) **System Time:** The unit's time and date can be manually configured here. Click in the empty box to open the time and date configuration screen and select the preferred values. After entering a new time and date, click the "Save" button to store it in the unit and start the clock running.
- 2) **Daylight Saving Time:** Enable or disable the use of DST adjustments for the unit's time.

Note: Enabling Daylight Saving Time while outside the configured DST range will result in no change to the current time.

- **Start:** Set the month, week, day and time for the start of DST in the current time zone.
- **End:** Set the month, week, day and time for the end of DST in the current time zone.

6.5 Telnet Control

Before attempting to use Telnet control, please ensure that both the unit and the PC are connected to the same active networks.

Start your preferred Telnet/Console client, or use the built in client provided by most modern computer operating systems. After starting the client, connect by using the current IP address of the unit and port 23 (if the communication port number used by the unit has not been changed previously). This will connect us to the unit we wish to control and commands may now be entered directly.

Note 1: If the IP address of the unit is changed then the IP address required for Telnet access will also change accordingly.

Note 2: This unit defaults to DHCP mode. The current IP address can be verified using the Device Discovery software. The default communication port is 23.

6.6 Serial and Telnet Commands

COMMAND
Description and Parameters
help ↵ Show the full command list.
help N1 ↵ Show details about the specified command. N1 = {Command Name}
? ↵ Show the full command list.
? N1 ↵ Show details about the specified command. N1 = {Command Name}
get fw ver ↵ Show the unit's current firmware version.

COMMAND	
Description and Parameters	
get command ver ↵	Show the unit's current command version.
get mac addr ↵	Show the unit's MAC address.
get model name ↵	Show the unit's model name.
get model type ↵	Show the unit's product type.
set factory default ↵	Reset the unit to the factory defaults.
set factory ipconfig default ↵	Reset the unit's IP configuration to the factory defaults.
get user config ↵	List the unit's current configuration information.
get update filename ↵	Show the unit's firmware update filename.
set nickname N1 ↵	Set the unit's nickname. N1 = {Name} [ASCII, 32 characters max]
get nickname ↵	Show the unit's current nickname.
set feedback broadcast N1 ↵	Enable or disable the broadcast of console command feedback. Available values for N1: ON [Enable the broadcast] OFF [Disable the broadcast]
get feedback broadcast ↵	Show the current console command feedback broadcast state.

COMMAND	
Description and Parameters	
get local echo ↵	Show the current local echo display setting.
set system reboot ↵	Reboot the unit.
set system led N1 ↵	Test the unit's LEDs by causing them to all blink, or turn off all LEDs. Available values for N1 : ON [Blink all LEDs] OFF [Turn off all LEDs]
set ip mode N1 ↵	Set the unit's IP address assignment mode. Available values for N1 : STATIC [Static IP mode] DHCP [DHCP mode]
get ip mode ↵	Show the current IP address assignment mode.
get ipconfig ↵	Show the unit's current IP configuration information.
get ipaddr ↵	Show the unit's current IP address.
get netmask ↵	Show the unit's current netmask.
get gateway ↵	Show the unit's current gateway address.
set static ipaddr N1 ↵	Set the unit's static IP address. N1 = X.X.X.X [X = 0~255, IP address]

COMMAND	
Description and Parameters	
get static ipaddr ↵	Show the unit's current static IP address.
set static netmask N1 ↵	Set the unit's static netmask. N1 = X.X.X.X [X = 0~255, netmask]
get static netmask ↵	Show the unit's current static netmask.
set static gateway N1 ↵	Set the unit's static gateway address. N1 = X.X.X.X [X = 0~255, gateway address]
get static gateway ↵	Show the unit's current static gateway address.
set webgui password N1 ↵	Set the WebGUI login password. N1 = {Password} [ASCII, 16 characters max]
get webgui password ↵	Show the current WebGUI login password.
get telnet username ↵	Show the current Telnet login username.
set telnet password N1 ↵	Set the Telnet login password. N1 = {Password} [ASCII, 32 characters max]
get telnet password ↵	Show the current Telnet login password.
set telnet port N1 ↵	Set the unit's Telnet access port. N1 = 1~65535 [Telnet port]

COMMAND	
Description and Parameters	
set telnet login N1 ↵	<p>Enable or disable requiring logging in to Telnet.</p> <p>Available values for N1:</p> <p>ON [Enable Telnet login requirement] OFF [Disable Telnet login requirement]</p>
get telnet login ↵	<p>Show the current state of Telnet login requirement.</p>
set key N1 led color N2 N3 ↵	<p>Set the LED color and brightness of the specified key.</p> <p>N1 = 1~8 [Key number]</p> <p>Available values for N2:</p> <p>RED [Red LED] BLUE [Blue LED] GREEN [Green LED]</p> <p>Available values for N3:</p> <p>0 [LED off (0% brightness)] 100 [LED on (100% brightness)]</p>
get key N1 led color ↵	<p>Show the current LED color and brightness values for the specified key.</p> <p>N1 = 1~8 [Key number]</p>
set macro N1 run ↵	<p>Run the specified macro immediately.</p> <p>N1 = 1~65 [Macro number]</p>
set cond N1 value N2 ↵	<p>Assign a value to the specified Condition Port.</p> <p>N1 = 1~64 [Condition port number] N2 = 0~255 [Condition value]</p>

COMMAND**Description and Parameters****set cond N1 value up N2 to N3↵**

Set a temporary min/max value range for the specified Condition Port and increase the stored value by 1.

N1 = 1~64 [Condition port number]
N2 = 0~255 [Adjustment minimum value]
N3 = 0~255 [Adjustment maximum value]

Note: If the current value is outside the defined min/max values it will jump to the nearest valid value.

set cond N1 value down N2 to N3↵

Set a temporary min/max value range for the specified Condition Port and decrease the stored value by 1.

N1 = 1~64 [Condition port number]
N2 = 0~255 [Adjustment minimum value]
N3 = 0~255 [Adjustment maximum value]

Note: If the current value is outside the defined min/max values it will jump to the nearest valid value.

get cond N1 value↵

Show the current value of the specified Condition Port.

N1 = 1~64 [Condition port number]

Note: Commands will not be executed unless followed by a carriage return. Commands are not case-sensitive.

7. CONNECTION DIAGRAM

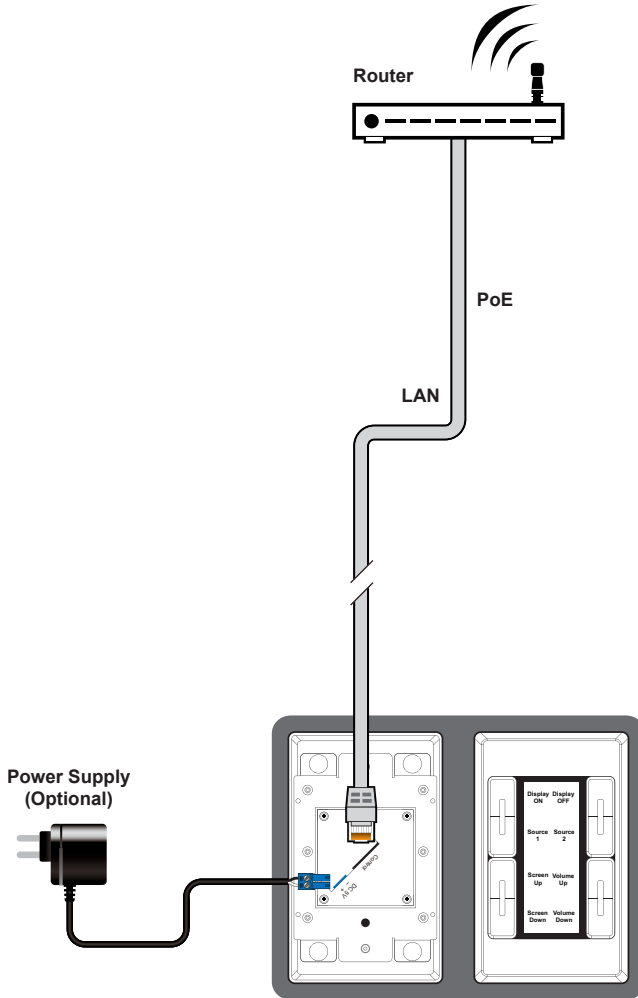

8. SPECIFICATIONS

8.1 Technical Specifications (US/US-W)

Control Interface	8×LED Buttons
Control Port	1×IP Control (RJ-45)
Service Port	1×USB 2.0 (Micro USB)
Power Supply	5V/2.6A DC (Optional) (US/EU standards, CE/FCC/UL certified) or PoE (802.3af)
ESD Protection (HBM)	±8kV (Air Discharge) ±4kV (Contact Discharge)
Dimensions (W×H×D)	114.3mm×69.8mm×40mm [Case Only] 114.3mm×69.8mm×40.5mm [All Inclusive]
Weight	200g
Chassis Material	Metal (Steel) & Plastic
Chassis Color	Black or White
Operating Temperature	0°C – 40°C/32°F – 104°F
Storage Temperature	-20°C – 60°C/-4°F – 140°F
Relative Humidity	20 – 90% RH (Non-condensing)
Power Consumption	1.1W

8.2 Technical Specifications (EUK/EUK-W)

Control Interface	8×LED Buttons
Control Port	1×IP Control (RJ-45)
Service Port	1×USB 2.0 (Micro USB)
Power Supply	5V/2.6A DC (Optional) (US/EU standards, CE/FCC/UL certified) or PoE (802.3af)
ESD Protection (HBM)	±8kV (Air Discharge) ±4kV (Contact Discharge)
Dimensions (W×H×D)	100mm×90mm×40mm [Case Only] 100mm×90mm×40.5mm [All Inclusive]
Weight	145g
Chassis Material	Metal (Steel) & Plastic
Chassis Color	Black or White
Operating Temperature	0°C – 40°C/32°F – 104°F
Storage Temperature	-20°C – 60°C/-4°F – 140°F
Relative Humidity	20 – 90% RH (Non-condensing)
Power Consumption	1.1W

9. ACRONYMS

ACRONYM	COMPLETE TERM
ASCII	American Standard Code for Information Interchange
Cat.5e	Enhanced Category 5 cable
Cat.6	Category 6 cable
Cat.6A	Augmented Category 6 cable
Cat.7	Category 7 cable
CLI	Command-Line Interface
DHCP	Dynamic Host Configuration Protocol
GUI	Graphical User Interface
IP	Internet Protocol
LAN	Local Area Network
LED	Light-Emitting Diode
MAC	Media Access Control
PD	Powered Device
PoE	Power over Ethernet
TCP	Transmission Control Protocol
USB	Universal Serial Bus



CYPRESS TECHNOLOGY CO., LTD.
www.cypress.com.tw
